

ALKALINE ZINC-MANGANESE BUTTON CELL

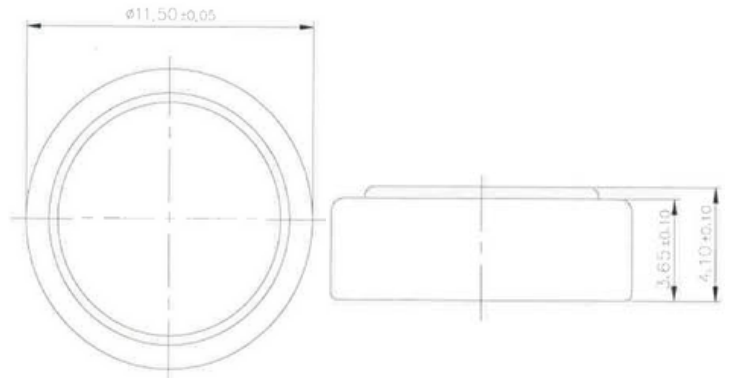

Size: AG12/LR43, 1.5V

Dimensions(GB)

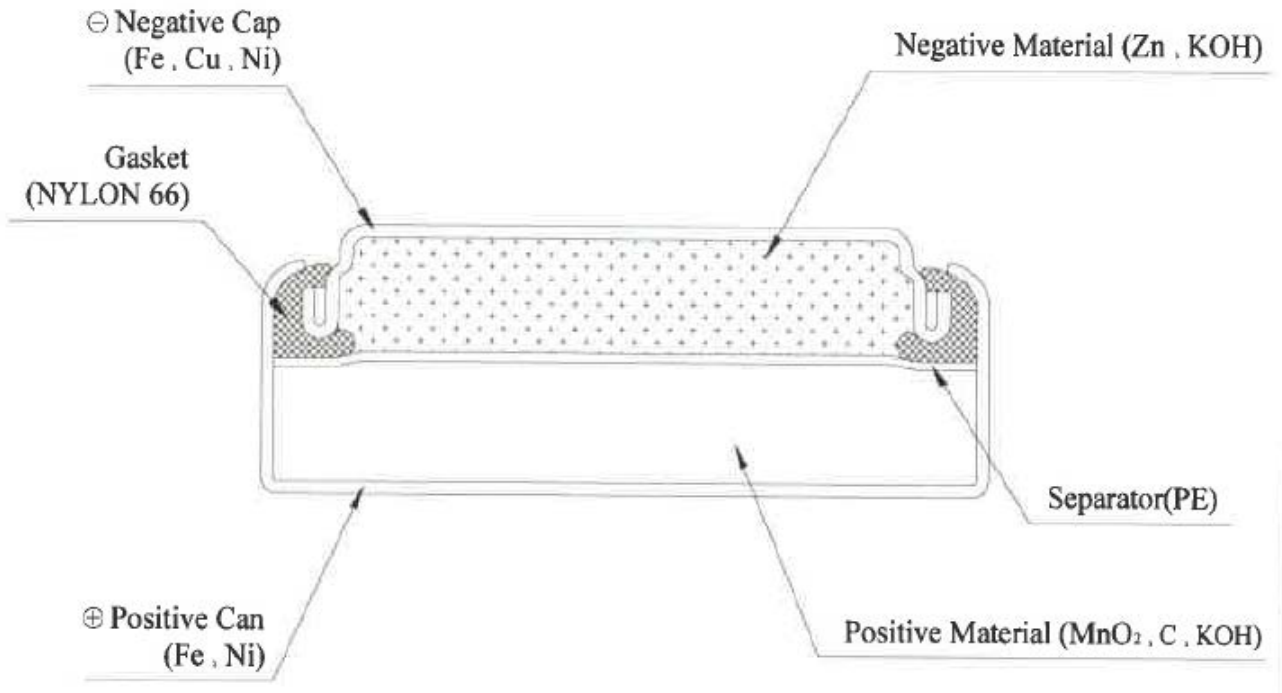

PHYSICAL CHARACTERISTICS

- Nominal capacity: 100mAh(continuously discharge at 20±2°C under 22kΩ load to 0.9V end-point voltage)
- Typical weight 1.48g

CERTIFICATES

- CE
- IEC60086
- RoHS
- MSDS
- Air Transportation Certificate
- Sea Transportation Certificate